

3.1 EUROPEAN CONTROLS

Individual and group control with tilt function

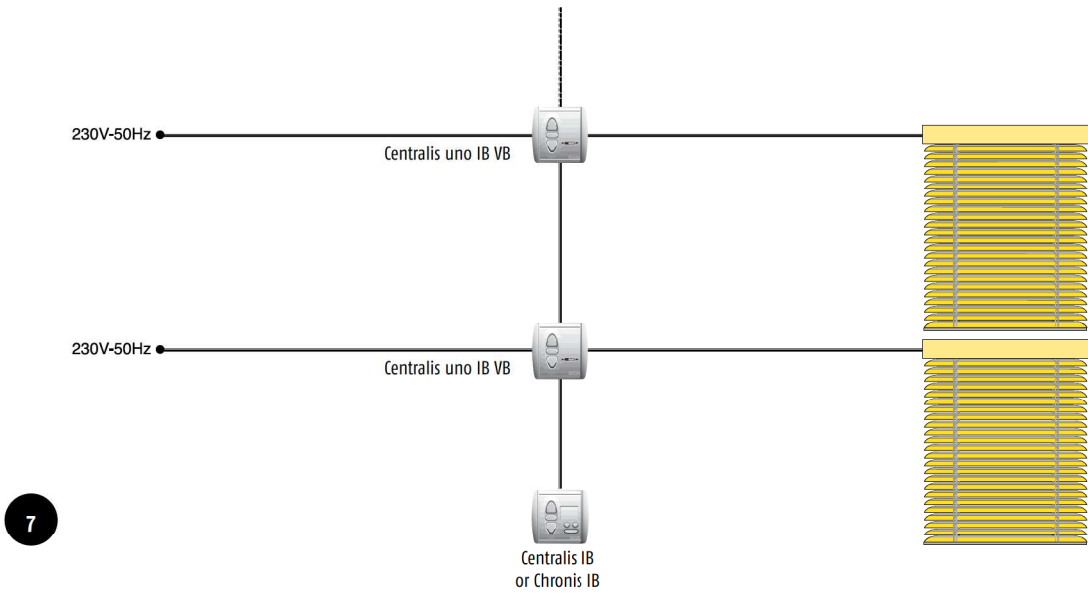

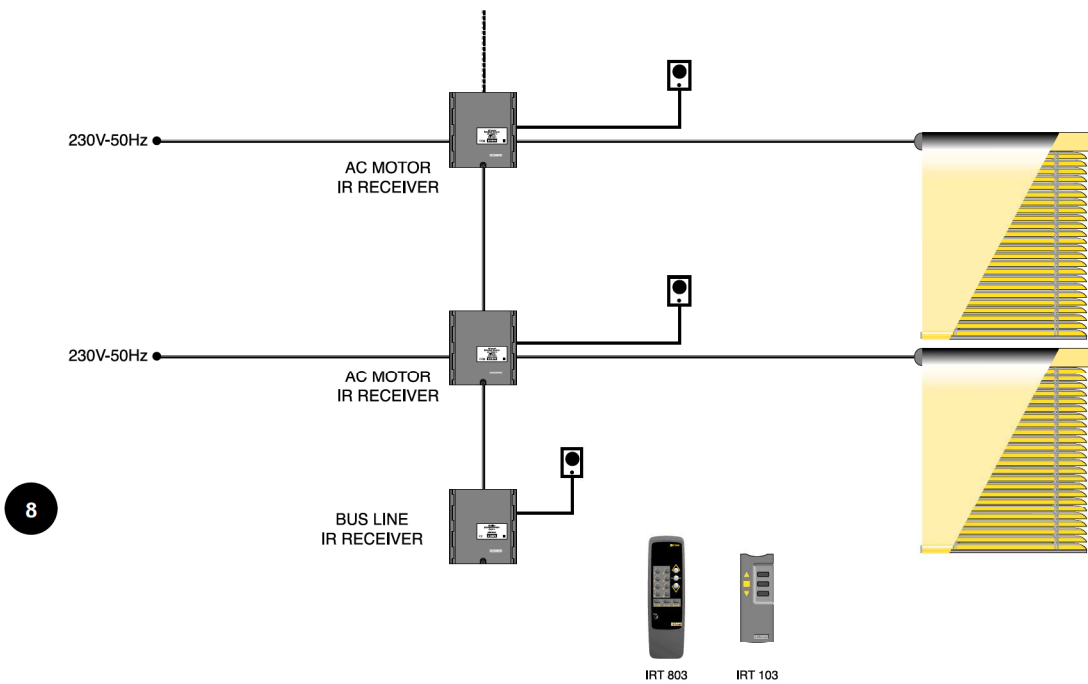









Individual and group control with IR





4.3 CONTROLS

	1810096	Centralis Indoor RTS	<ul style="list-style-type: none"> - Radio receiver
	1810110	SL7070 Draper	<ul style="list-style-type: none"> - Radio receiver - For venetians with tilt function
	1870011	IRT 103	<ul style="list-style-type: none"> - IR transmitter for IRS 100 & 200 - Supplied without batteries - 3 buttons for up, down, stop - Quantity per standard package: 1 - Weight: 45 g - Dimensions: 118 x 45 x 14
	1870010	IRT 803	<ul style="list-style-type: none"> - 8 channel infrared transmitter for IRS 300 - Subgroup control 1-4 and 5-8 - Group control 1-8 - Supplied with batteries - Quantity per standard package: 1 - Weight: 101 g - Dimensions: 162x50x20
	9154186	IR Sensor	<ul style="list-style-type: none"> - Individual control - For bus line and AC motor infrared receivers - Quantity per standard package: 1 - Weight: 67 g - Dimensions:
	1822033	Bus line Infra-red Receiver	<ul style="list-style-type: none"> - Control for Somfy BUS line by infra-red transmitter (IRT 103, IRT 803) or external input (individual push-button or Somfy Bus line). - 220-240 V - Colour: grey - Dimensions: 135 x 120 x 42 - Weight: 330 g
	1860000	AC motor Infra-red Receiver	<ul style="list-style-type: none"> - Control for Somfy BUS line by infra-red transmitter (IRT 103; IRT 803) or external input (individual push-button or Somfy Bus line). - 220-240 V - 3 different «Drape» functions for venetian blinds - Colour: grey - Dimensions: 135 x 120 x 42 - Weight: 330 g
	1810000	CD 4 Drap	<ul style="list-style-type: none"> - Individual control with tilt function - Bus line connection for group control - 1 per motor - Quantity per standard package: 1 - Weight: 400 g - Dimensions: 112 x 52 x 106
	1810058	GR 4	<ul style="list-style-type: none"> - Group control unit for max. 4 motors - Quantity per standard package: 1 - Weight: 480 g - Dimensions: 150 x 105 x 75
	1870065	White rocker switch S51 AC	<ul style="list-style-type: none"> - 5 positions white AC rocker switch - Screw connectors - Contact rating max 3 A - 2 momentary positions for pulse tilting - 2 fixed positions for lifting - Quantity per standard package: 1 - Weight: 25 g
	9660135	Switch box	<ul style="list-style-type: none"> - Surface mounting box for # 660101/660102/660103 - Quantity per standard package: 1 - Weight: 40 g - Dimensions: 86 x 42 x 39

All information subject to change
©SOMFY.COM980500. All rights reserved. 05/2003