

animeo[®] IB +

Building Controller







DIN Rail Mounted version • Version Rail DIN • **DIN rail montage** • DIN hutschiene version • **Versione montaggio su guida DIN** • DIN monterad version • **DIN monteret version** • **DIN kiskoon asennettava malli**





ref : 1822064 (240V)

ref : 1822065 (120V)

CONTENTS • SOMMAIRE • INHOUDSOPGAVE • INHALTSVERZEICHNIS

1	Housing preparation	Préparation du boîtier	Vorbereitung behuizing	Gehäusevorbereitung
2	Cabling 	Câblage 	Bekabeling 	Verkabelung 
3	Visualization	Visualisation	Visualisering	Anzeige

SOMMARIO • INNEHÅLL • INNHOLD • SISÄLTÖ

1	Preparazione della zona di installazione	Förberedelser för datorns installation	Forberede installasjon	Sisätilojen valmistelu
2	Cablaggio 	Kablage 	Kabling 	Kaapelointi 
3	Visualizzazione	Visualisering	Visualisering	Visualisointi

GB The Building Controller is an electronic, independently mounted control.

type 1 action;

Pollutiondegree 2

Rated impulse voltage 4kV

Temperature of the ball hardness test: 75°C

D Der Building Controller ist ein elektronisches, unabhängig montiertes Regel- und Steuergerät.

Wirkungsweise Typ 1;

Verschmutzungsgrad 2

Bemessungs-Stossspannung: 4kV

Temperatur der Kugeldruckprüfung: 75°C

GB Before installation, please read the safety instructions included in this sheet carefully. Failure to respect these instructions automatically invalidates the guarantee as well as all liability claims against Somfy. Somfy cannot be held responsible for any changes in norms and standards introduced after the publication of this guide.

F Avant la mise en œuvre veuillez lire les instructions de sécurité ci-jointes. Le non-respect de ces instructions annule la responsabilité de SOMFY et sa garantie. SOMFY ne peut être tenue responsable des changements de normes et standards intervenus après la publication de cette notice.

NL Lees de bijgevoegde veiligheidsinstructie s.v.p. aandachtig door voordat u begint met de installatie.

Door het niet respecteren van deze instructies vervalt de garantie en de verantwoordelijkheid van Somfy. Somfy is niet verantwoordelijk voor veranderingen in normen en standaarden die tot stand zijn gekomen na de publicatie van deze montagehandleiding.

D Vor Inbetriebnahme unbedingt die Sicherheitsanweisungen auf beiliegendem Blatt beachten. Bei Nichtbeachten der Gebrauchsanweisung entfällt die Somfy Gewährleistung. Somfy ist nicht haftbar für Änderungen der Normen und Standards nach Erscheinen der Gebrauchsanweisung. "Errichten, Prüfen und Inbetriebsetzen des 230 V-Anschlusses darf nur von einer Elektrofachkraft (lt. VDE 0100) durchgeführt werden! Schalten Sie alle zu montierenden Anschlussleitungen spannungslos! Treffen Sie Sicherheitsvorkehrungen gegen unbeabsichtigtes Einschalten!"

I Prima dell'installazione per favore leggere attentamente le istruzioni di sicurezza sul foglio allegato.

Il mancato rispetto di queste istruzioni annulla la responsabilità e la garanzia SOMFY. SOMFY non può essere ritenuta responsabile per qualsiasi cambiamento alle norme e agli standard introdotti dopo la pubblicazione di questa guida.

S Innan installasjon, läs noga genom säkerhetsföreskrifterna på det medföljande bladet.

Om dessa föreskrifterna inte följs upphör Somfys ansvar och garanti. SOMFY kan inte hållas ansvarig för förändringar i normer och standarder som införs efter att dessa anvisningar publicerats.

N Før innstallasjon. Les nøye gjennom sikkerhetsforskrifterne på det vedlagte arket. Dersom disse forskrifter ikke blir fulgt, opphører Somfys ansvar og garanti. SOMFY kan ikke stilles til ansvar for forandringer i normer og standarder som innføres etter at disse anvisningene er publisert.

SF Ennen asennuksen aloittamista lue huolellisesti liitteessä olevat turvallisuusohjeet. Jos näitä määräyksiä ei noudateta, Somfyn vastuu ja takuu raukeavat. SOMFY:a ei voida asettaa vastuuseen näiden ohjeiden julkistamisen jälkeisistä normien ja standardien muutoksista.

- GB** Choose the optimal location:
DIN rail in Electrical Cabinet
I Scegliere la posizione ottimale:
guida DIN in quadro elettrico

- F** Choisir le meilleur emplacement:
Rail DIN dans l'armoire électrique
S Välj rätt placering:
DIN-rail i elskåpet

- NL** Kies de juiste plaats:
DIN-rail in de schakelkast
N Velg riktig plasering:
DIN-skinne i elskapet

- D** Wahl des richtigen Montageorts:
DIN-Hutschienen im Schaltschrank
SF Valitse oikea paikka:
DIN kisko sähkökaapissa

DIN Rail Mounted version • Version Rail DIN • DIN rail montage • Hutschienen Version • Versione montaggio su guida DIN • DIN monterad version • DIN monterat version • DIN kiskoon asennettava malli

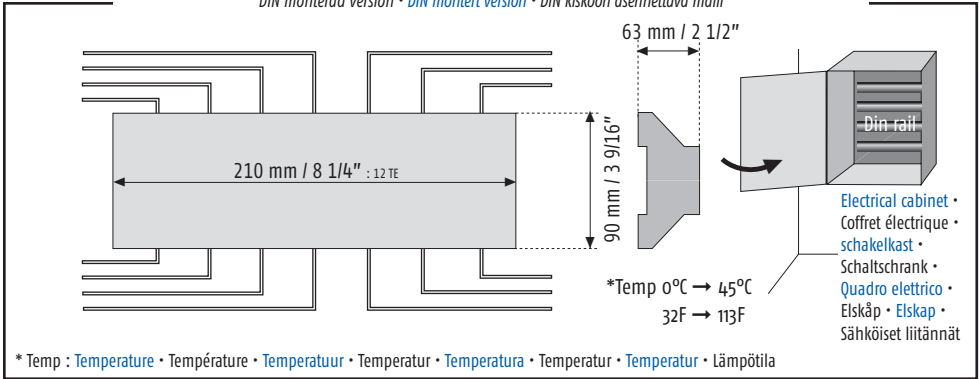

- GB** Mount the "Building Controller"
I Montare il "Building Controller"

- F** Fixer le "Building Controller"
S Montera "Building Controller"

- NL** Monteer de "Building Controller"
N Monter "Building Controller"

- D** Montage des "Building Controller"
SF Asenna moottoriyksikkö "Building Controller"

DIN Rail Mounted version • Version Rail DIN • DIN rail montage • Hutschienen Version • Versione montaggio su guida DIN • DIN monterad version • DIN monterat version • DIN kiskoon asennettava malli

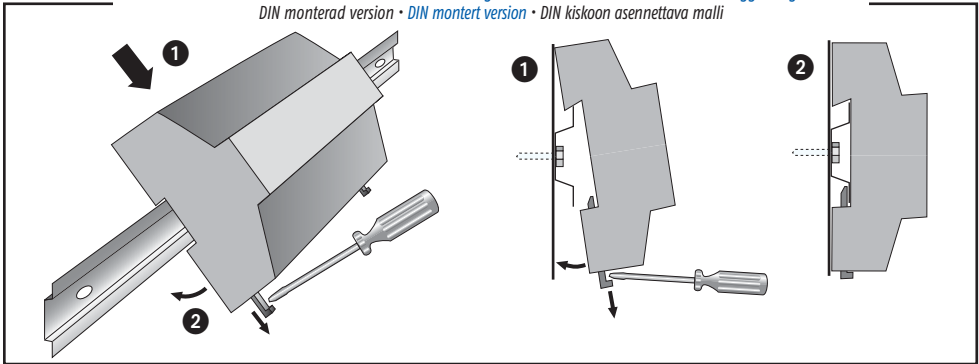

- GB** Strip the cables and the wires

- F** Dénuder les câbles et les fils électriques

- NL** Strip de kabels en de snoeren

- D** Kabel und Drähte abisolieren

- I** Effettuare il cablaggio

- S** Skala kablaarna

- N** Avisoler kablene

- SF** Paljasta kaapelit ja johdot

DIN Rail Mounted version • Version Rail DIN • DIN rail montage • Hutschienen Version • Versione montaggio su guida DIN • DIN monterad version • DIN monterat version • DIN kiskoon asennettava malli

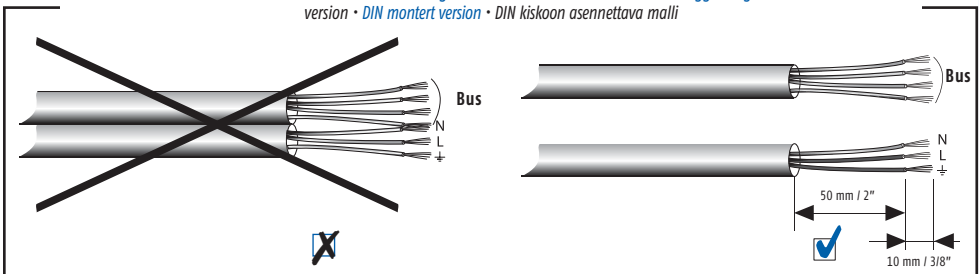

GB Connect power supply and wiring to other controls.

I Connettere l'alimentazione e cablare gli altri controlli

F Connecter l'alimentation et les fils électriques vers d'autres automatismes

S Anslut matnings- och övriga kablar till övriga kontroller

NL Sluit de netspanning en de bedrading naar andere besturingen aan

H Tilkoble strøm og øvrige kabler Til øvrige kontroller

D Spannungsversorgung anschliessen und die weiteren Produkte verdrahten

SF Kytke virtalähde ja johdotukset

DIN Rail Mounted version • Version Rail DIN • DIN rail montage • Hutschienen Version • Versione montaggio su guida DIN • DIN monterad version • DIN monterat version • DIN kiskoon osennettava malli

	Connection to... • Connexion aux... • Aansluiting naar... • Anschluss an... • Connettere a... • Anslutning till... • Tilkobling til... • Liitos...	Cable • Câble • Kabel • Leitung • Cavo • Kabel • Kabel • Kaapeli	Twisted pairs • Paires torsadées • Twisted pair • verdilltes Adempaar • Doppino • Partvinnad kabel • Tvinnet par • Kierretty parit	Max. distance • Longueur Maximum • Max. Lengte • Max. Länge • Max. Distanza • Max. avstånd • Max. Avstand • Max. etäisyys
A	input • Entrée • ingång • Eingang • input • ingång • Ingang • tulo	Min. : 2 x 0.6mm ² / 19 AWG – Max. : 2 x 2.5mm ² / 13 AWG	-	150 m / 500ft
B	Central switch • Interrupteur central • Centrale schakelaar • Zentraltaster • Interruttore centrale • Centralströmbrytare • Hovedbryter • Pääkatkaisin	Min. : 3 x 0.6mm ² / 19 AWG – Max. : 3 x 2.5mm ² / 13 AWG	-	50 m / 165ft
C	Error Output • Sortie d'erreur • Uitvoer fouten • Ausgabe von Fehlerausgang • Uscita Errori • Felvisning • Feilutgang • Virheellinen tulos	Min. : 3 x 0.6mm ² / 19 AWG – Max. : 3 x 2.5mm ² / 13 AWG	-	100 m / 330ft
D	IB+ input / output • IB+ Entrée / Sortie • IB+ ingång / utgång • IB+ Ein-/Ausgang • IB+ input / output • IB+ ingång / utgång • IB+ Ingang/utgang • IB+ tulo / lähtö	Min. : 4 x 0.6mm ² / 19 AWG – Max. : 4 x 1.5mm ² / 16 AWG	Recommended (2 x 2) • Conseillé (2 x 2) • Aanbevolen (2 x 2) • empfohlen (2 x 2) • Consigliato (2 x 2) • Rekomenderas (2 x 2) • Rekomanderes (2 x 2) • Suositeltavaa (2 x 2)	1000 m / 3300ft
E	RS485 4-wire network • Réseau RS485 à 4 fils • Network RS485 met 4 draden • RS485 4-Leiternetzwerk • Rete RS 485 a 4 fili • RS485-nät med 4 ledare • RS485-nett med 4 ledningar • RS485 4-johito verkko	Min. : 4 x 0.6mm ² / 19 AWG – Max. : 4 x 0.8mm ² / 18 AWG	Required (2 x 2) • Obligatoire (2 x 2) • Verplicht (2 x 2) • Notwendig (2 x 2) • Obligatorio (2 x 2) • Krav (2 x 2) • Krav (2 x 2) • Pakollista (2 x 2)	1000 m / 3300ft
F	RS485 2-wire network • Réseau RS485 à 2 fils • Network RS485 met 2 draden • RS485 2-Leiternetzwerk • Rete RS 485 a 2 fili • RS485-nät med 2 ledare • RS485-nett med 2 ledningar • RS485 2-johito verkko	Min. : 2 x 0.6mm ² / 19 AWG – Max. : 2 x 0.8mm ² / 18 AWG	Required • Obligatoire • Verplicht • Notwendig • Obligatorio • Krav • Krav • Pakollista	1000 m / 3300ft
G	120-Ohm resistance only required at the beginning and at the end of the RS485 2-wire network • La résistance de 120 Ohms n'est requise qu'au début et à la fin du réseau RS485 à 2 fils • De weerstand van 120 Ohm is alleen aan het begin en aan het einde van het network RS485 met 2 draden vereist • 120-Ohm Widerstand nur zu Beginn und am Ende des RS485 2-Leiternetzwerks erforderlich • La resistenza da 120 Ohm è richiesta solo all'inizio ed alla fine della rete RS 485 a 2 fili • Motståndet på 120 Ohm behövs endast vid starten och stängningen av RS485-nätet med 2 ledare • Motstanden på 120 ohm er kun nødvendig på begynnelsen og slutten av RS485-nettet med 2 ledninger • 120-Ohmin vastus tarvitaan vain RS485 2-johitoisen verkon alussa ja lopussa			

GB Connect power supply and wiring to other controls

I Connettere l'alimentazione e cablare gli altri controlli

F Connecter l'alimentation et les fils électriques vers d'autres automatismes

S Anslut matnings- och övriga kablar till övriga kontrollen

NL Sluit de netspanning en de bedrading naar andere besturingen aan

N Tilkoble strøm og øvrige kabler til øvrige kontrollen

D Spannungsversorgung anschliessen und fertig verdrahten

SF Kytke virtalähde ja johdotukset

DIN Rail Mounted version • Version Rail DIN • DIN rail montage • Hutschienen Version • Versione montaggio su guida DIN • DIN monterad version • DIN montert version • DIN kiskoon asennettava malli

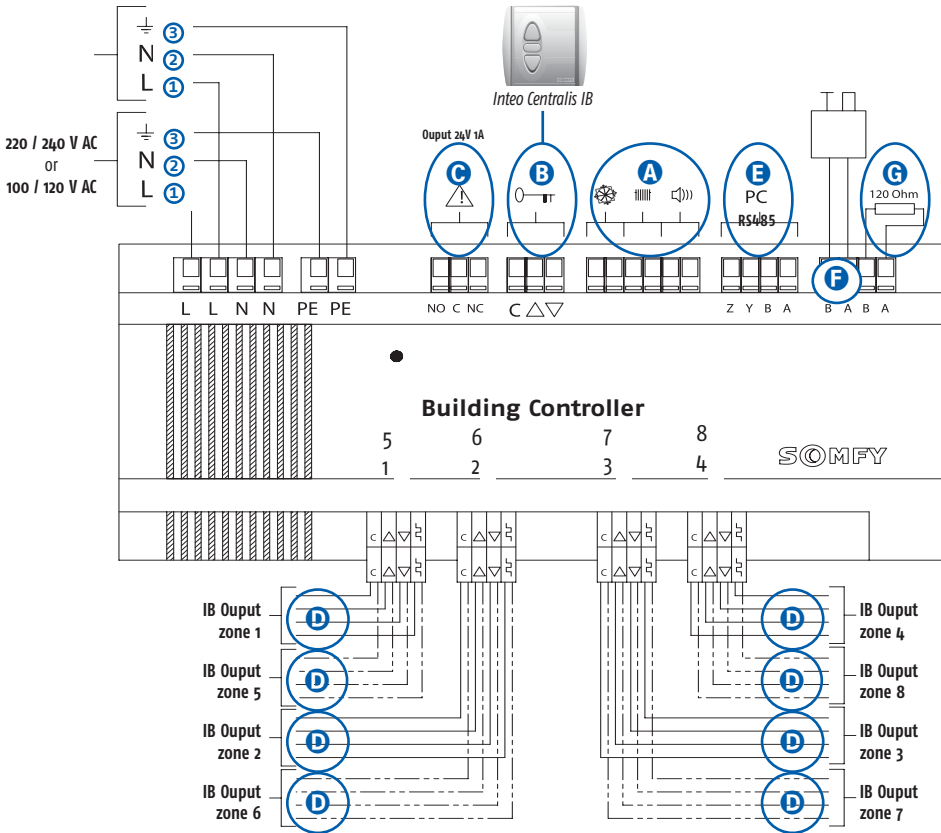

230 V / 50 Hz		
①	②	③
Brown	Blue	Green-yellow
Marron	Bleu	Vert-jaune
Bruin	Blauw	Geel/groen
Braun	Blauw	Gelb-Grün
Marrone	Blu	Giallo/verde
Brun	Blå	Grön/gul
Brun	Blå	Grønn/gul
Ruskea	Sininen	Vihreä/keltainen

120 V / 60 Hz		
①	②	③
Black	White	Green
Noir	Blanc	Vert
Zwart	Wit	Groen
Schwarz	Weiß	Grün
Nero	Bianco	Verde
Svart	Vit	Grön
Sort	Hvit	Grønn
Musta	Valkoinen	Vihreä

L	N	⏏
Live phase	Neutral	Earth
Fase	neutre	terre
Phase	nul	Aarde
fase	Neutralleiter	Erde
ffas	neutro	terra
fase	nolla	jord
fvaihe	null	jord
	nolla	Maadoitus

GB RS 485/BuCo
I RS 485/BuCo

F RS 485/BuCo
S RS 485/BuCo

NL RS 485/BuCo
N RS 485/BuCo

D RS 485/BuCo
SF RS 485/BuCo

DIN Rail Mounted version • Version Rail DIN • DIN rail montage • Hutschienen Version • Versione montaggio su guida DIN • DIN monterad version • DIN monterter version • DIN kiskoon asennettava malli

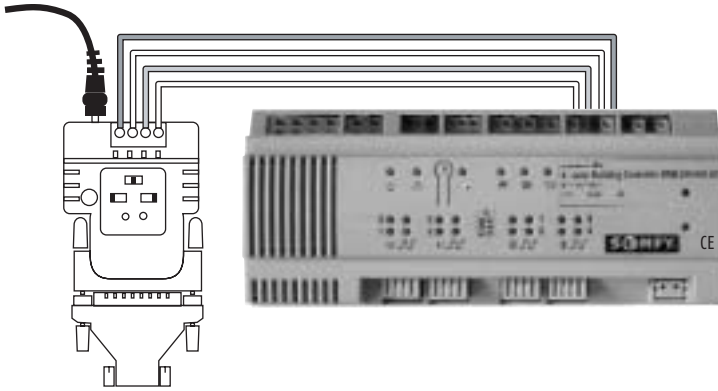

GB Other screwless connectors
I Altri connettori senza vite

F Autres connecteurs sans vis
S Övriga skruvlösa anslutningar

NL Overige drukconnectoren
N Øvrige skrueløse tilkoblinger

D Federzugklemmen
SF Muut ruuvittomat liittimet

DIN Rail Mounted version • Version Rail DIN • DIN rail montage • Hutschienen Version • Versione montaggio su guida DIN • DIN monterad version • DIN monterter version • DIN kiskoon asennettava malli

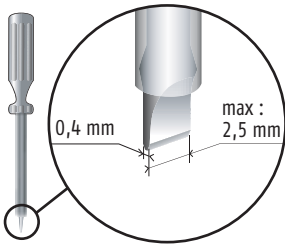

Insulated Screwdriver • Tournevis isolé • Geïsoleerde schroeven-draaier • isolierter Schraubendreher • Cacciavite isolato • Isolerad skruvmejsel • Isolert skrutrekker • Eristetty ruuvitaltan terä

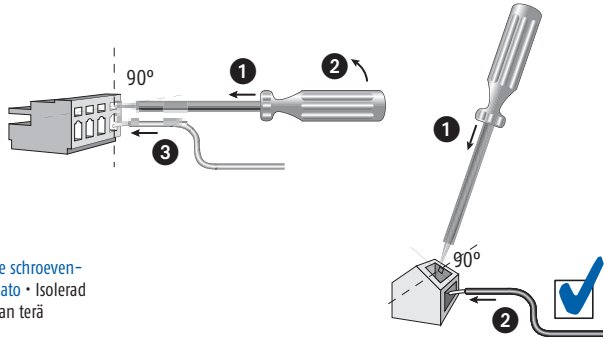

GB Possible switches

F Boutons poussoirs compatibles avec les Building Controllers

NL Mogelijke schakelaars

D mögliche Taster

I Possibili doppi pulsanti

S Möjliga brytare

N Mulige brytere

SF Mahdolliset kytkimet

DIN Rail Mounted version • Version Rail DIN • DIN rail montage • Hutschienen Version • Versione montaggio su guida DIN • DIN monterad version • DIN monterter version • DIN kiskoon asennettava malli



Inteo Centralis IB

or
ou
of
oder
o
eller
eller
tai



Double push button • Boutons double poussoirs • impulschakelaarmet • Doppeltaster • doppi pulsanti • Möjliga brytare • Mulige brytere • Mahdolliset kytkimet

GB In use
I Durante l'uso

F Durant l'utilisation
S Under användning

NL Tijdens het gebruik
N ved bruk

D Während des Betriebs
SF Käytössä

DIN Rail Mounted version • Version Rail DIN • DIN rail montage • Hutschienen Version • Versione montaggio su guida DIN • DIN monterad version • DIN monteret version • DIN kiskoon asennettava malli



Power supply • Alimentation électrique • Voeding • Stromversorgung • Alimentazione elettrica • strömförsörjning • Strømtilførsel • Virtalähde

Error Output • Sortie d'erreur • Uitvoer fouten • Fehleranzeige • Uscita Errori • Felvisning • felmeddelande • Virheellinen tulos

Central switch • Interrupteur central • Centrale schakelaar • Hauptschalter • Interruttore centrale • huvudbrytare • Hovedbryter • Pääkatkaisin

HVAC cooling • Refroidissement HVAC • Koeling HVAC • HKL-Kühlung • Raffreddamento HVAC • HVAC-kyla • HVAC-nejkøling • HVAC jäähdytys

HVAC heating • Chauffage HVAC • Verwarming HVAC • HKL-Heizung • Riscaldamento HVAC • HVAC-värme • HVAC-oppvarming • HVAC kuumennus

Major Alarm • Alarme majeure • Hoofdalarm • Alarm • Allarme grave • Huvudalarm • Hovedalarm • Päähälytyn

IB output: 1 multicolour LED • Sortie IB: 1 DEL multicolore • IB-utgång: 1 meerkleurige LED • IB Ausgang: 1 mehrfarbige LED • Uscita IB: 1 LED multicolore • IB-utgång: 1 flerfärgad lysdiod • IB-utgång: 1 indikatorlampe med flere farger • IB ulostulo: 1 monivärinen LED

IB + Data output • Sortie IB + Données • IB-utgång + gegevens • IB + Datenausgang • Uscita IB + Dati • IB-utgång + Data • IB- + datautgång • IB + Data ulostulo

Reset pushbutton • Bouton poussoir de RAZ • RESET-drukknop • Reset-Taste • Pulsante per il reset • Tryckknapp för återställning • reset knapp • Alkuasetuspainike

>10s = reset

GB Trouble shooting
I Soluzione dei problemi

F Diagnostic
S Felsökning

NL Probleemoplossing
N Feilsøking

D Fehlersuche
SF Vian etsintä

DIN Rail Mounted version • Version Rail DIN • DIN rail montage • Hutschienen Version • Versione montaggio su guida DIN • DIN monterad version • DIN monteret version • DIN kiskoon asennettava malli

GB The motor does not work. Check:

- Motor Controller cabling (see point 2).
- Power ON: Green LED should be ON.
- If the LED blinks, check software manual or connect PC.

F Le moteur ne fonctionne pas, Vérifier :

- Le câblage du Motor Controller (voir point 2).
- Alimentation (Power ON): La LED verte doit être ALLUMÉE.
- Si la LED clignote, vérifier le manuel du logiciel ou connecter le PC.

NL De motor werkt niet. Controleer:

- De bedrading op de Motor Controller (zie handleiding motor controller).
- Voeding (Power ON): De groene LED moet BRANDEN.
- Controleer de handleiding van de software of sluit de PC aan indien de LED knippert.

D Der Antrieb läuft nicht, folgendes überprüfen:

- Anschluss des Motorsteuergerätes (Siehe Punkt 2).
- Power ON: Grüne LED sollte auf ON stehen.
- Bei blinkender LED, im Softwarehandbuch nachschlagen oder PC anschließen.

I Il motore non lavora, verificare :

- Il cablaggio del Motor Controller (vedi punto 2).
- Alimentazione attivata (ON) : Il LED verde deve essere ACCESSO di continuo.
- Se il LED lampeggia, verificare il manuale del software o collegare il PC.

S Motorn fungerer inte, Undersök :

- Kabeln till motorkontroll (MoCo) (se punkt 2).
- Elförsörjning (Power ON): Den gröna lysdioden skall vara TÄND.
- Om lysdioden blinkar skall du kontrollera programvarans manual eller ansluta PC:n.

N Motoren fungerer ikke, Undersøk :

- Kabelen til motorkontrollen (MoCo) (se punkt 2).
- Strømtilførsel (Power ON): Den grønne lampen skal være TENT.
- Hvis lampen blinker, sjekk programvarehåndboken eller koble til PCen.

SF Moottori ei toimi, Varmista:

- Moottoriyksikön (MoCo) kytkennät (katso kohta 2).
- Virta päällä: vihreän LED:n täytyy palaa.
- Jos LED vilkkuu, tarkista ohjelmiston käyttöohjeesta tai liitä PC.

1

2

3

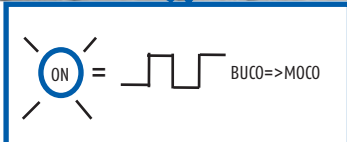
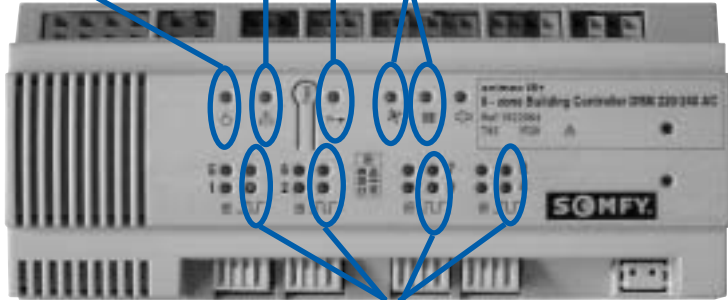
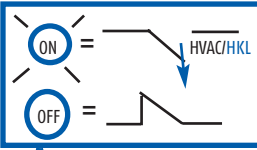
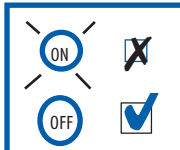
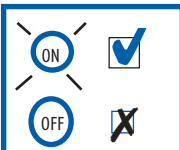
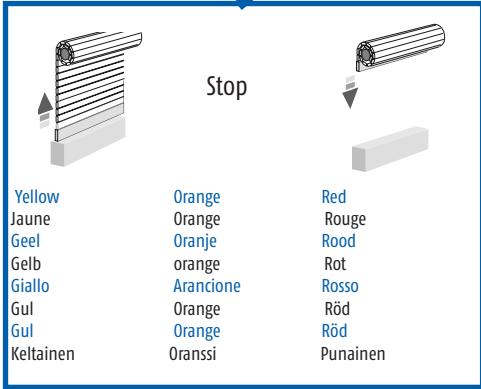
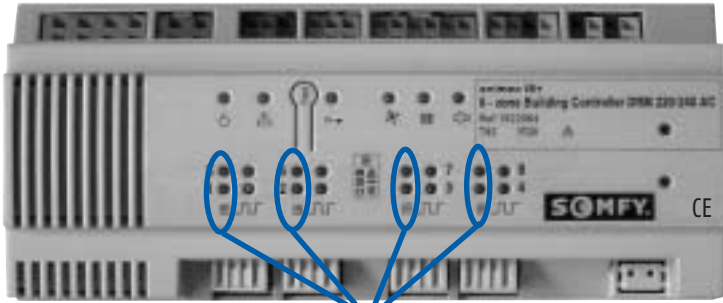

Technical Data.

Building Controller IB+

Supply	Voltage.	220 VAC - 240VAC
		100 VAC - 120 VAC
		50 Hz - 60 Hz
	Frequency.	43 mA 86 mA
Mechanical Data.	Max. operating current (primary).	DIN Rail.
	Housing.	12 TE = 210 mm / 63 mm / 90 mm
	Length. / Height. / Width.	660 g
	Weight.	type.: CC-ABS polycarbonat
	Plastic.	mass.: 210 g
	Housing material.	Recyclable.
Protection Class.	IP20	
Inputs. / Outputs.	General.	Short circuit secured.
Inputs.	Major alarm.	To be controlled with normally closed contact.
	HVAC Heating.	To be controlled with normally open contact.
	HVAC Cooling.	
	Central switch.	double pushbutton. (C., UP. DOWN.)
Potential free Output.	Error.	Dry contact, normally closed, 24 V / 1 A max.
Fuse.	Thermal fuse.	Self resetable fuse or Polyswitch.
Temperature ranges.	Operating temperature.	0°C to 45°C
	Storage temperature.	-20°C to 70°C
	Relative humidity.	85%
EMC.	EN 60 730-1	
Standards compliance.	EN 60 730-1, IEC 730 (electric safety devices.), EN 60 721-3-1/2	
Approvals.	ENEC 10, UL	



1

2

3

4

5

6

7



A series of horizontal lines for writing, arranged in two columns of 25 lines each.

- 1
- 2
- 3
- 4
- 5
- 6
- 7

SOMFYwww.somfy.com

Australia :
SOMFY PTY LTD
www.somfy.com.au

Austria :
SOMFY GesmbH
www.somfy.at

Belgium :
NV SOMFY SA
www.somfy.be

Brasil :
SOMFY BRASIL STDA
www.somfy.com

Canada :
SOMFY ULC
www.somfy.com

Cyprus :
SOMFY MIDDLE EAST
www.somfy.com

Czech Republic :
SOMFY Spol s.r.o.
www.somfy.com

Denmark :
SOMFY Nordic AB
DENMARK
www.Somfy.dk

Finland :
SOMFY Nordic AB
FINLAND
www.Somfy.fi

France :
SOMFY FRANCE
www.somfy.fr

Germany :
SOMFY GmbH
www.somfy.de

Greece :
SOMFY HELLAS
www.somfy.com

Hong Kong :
SOMFY Co. Ltd
www.somfy.com

Hungary :
SOMFY Kft
www.somfy.com

India :
SOMFY INDIA PVT Ltd
www.somfy.com

Italy :
SOMFY ITALIA s.r.l
www.somfy.it

Japan :
SOMFY KK
www.somfy.co.jp

Lebanon :
cf. Cyprus - SOMFY
MIDDLE EAST
www.somfy.com

Mexico :
SOMFY MEXICO SA de CV
www.somfy.com.mx

Morocco :
SOMFY MAROC
www.somfy.com

Netherlands :
SOMFY BV
www.somfy.nl

Norway :
SOMFY Nordic
NORWAY
www.Somfy.no

Poland :
SOMFY SP Z.O.O
www.somfy.pl

Portugal : cf. Spain -
SOMFY ESPANA SA
www.somfy.com

Russia : cf. Germany -
SOMFY GmbH
www.somfy.de

Singapore :
SOMFY PTE LTD
www.somfy.com.sg

Slovaquia : cf. Czech
Republic -
SOMFY Spol s.r.o.
www.somfy.com

South Korea :
SOMFY JOO
www.somfy.co.kr

Spain :
SOMFY ESPANA SA
www.somfy.com

Sweden :
SOMFY Nordic AB
www.Somfy.se

Switzerland :
SOMFY A.G.
www.somfy.ch

Taiwan :
SOMFY TAIWAN
www.somfy.com

United Kingdom :
SOMFY LTD
www.somfy.co.uk

United States :
SOMFY SYSTEMS Inc
www.somfysystems.com

